

D R Burton iPEP® with HC PōcketPEP®

# Incentive Positive Expiratory Pressure Therapy System

Instructions for Use

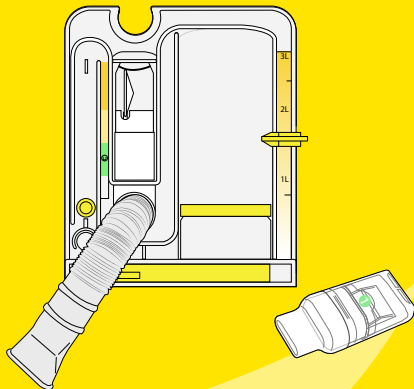

Rx only

# Contents

iPEP parts . . . . .	1
Important information. . . . .	2
Using your iPEP in hospital . . . . .	6
Using the spirometer in hospital . . . . .	14
Using your PocketPEP at home. . . . .	21
Cleaning the PocketPEP at home . . . . .	29
Chart A: Patient Progress Chart for Incentive Spirometer-Only Use . . . . .	37
Chart B: Predictive Nomograms – Inspiratory Capacity (mL) . . . . .	39

# iPEP® parts

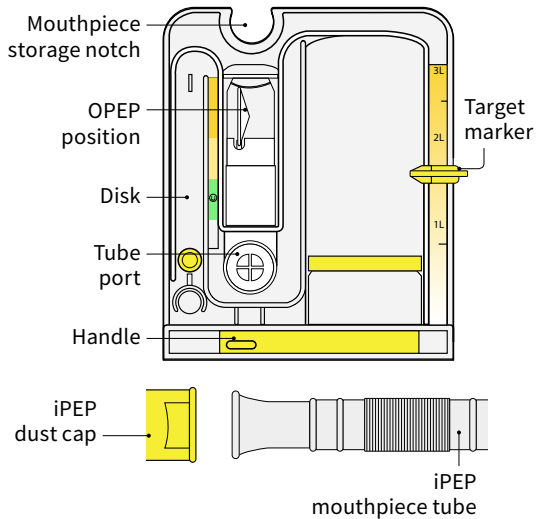

# PocketPEP® parts

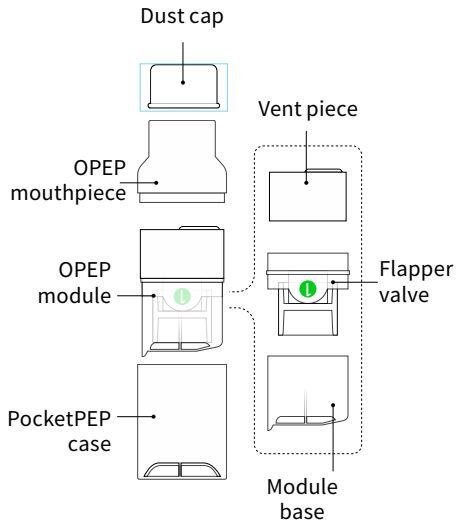

# Important information

- Read all of the Instructions for use before using this product. The iPEP will not work unless it is used properly.
- If you do not follow the Instructions for use this could result in death or serious injury.
- Talk to your healthcare practitioner about using the iPEP.

## **Intended use**

The D R Burton iPEP Therapy System is intended for use as an Oscillating Positive Expiratory Pressure (OPEP) device by patients capable of generating an exhalation flow of 10 liters per minute for 3 – 4 seconds and an Incentive Spirometer as an inspiratory, deep breathing, positive exerciser. Intended for single-patient, multi-use in a hospital or home care setting.

## **What the iPEP is used for (Description)**

The D R Burton iPEP is an aid to loosen and remove bronchial secretions associated with:

- COPD (chronic obstructive pulmonary disease)
- Cystic fibrosis (bronchiectasis)
- Breathlessness (pulmonary emphysema)
- Asthma
- Nonproductive cough
- Smoker's cough
- Collapsed lung (treatment of atelectasis).

The iPEP is also a device used to help lung health after surgery, or for lung illness, such as pneumonia, by teaching patients how to take slow deep breaths.

## **Precautions**

- Ensure contraindications are observed
- Do not leave children alone with the device
- The device is for use by one patient and should not be shared.

## Important information

### **When iPEP must not be used**

Use of the iPEP is not recommended for:

- Patients not able to tolerate the increased work of breathing
- High pressure in the brain (called intracranial pressure (ICP) more than 20 mm Hg)
- Unstable blood pressure (hemodynamic instability)
- Recent face, mouth or skull surgery or trauma
- Acute sinusitis
- Nose bleed
- Surgery on the throat
- Feeling sick (nausea)
- Current bleeding from the lungs
- Untreated collapsed lung
- Possible ruptured ear drum or similar ear problems.

### **Warning: using iPEP at high pressure**

Using iPEP at pressures which are too high may have side effects. Pressures breathing out above 20 cm H<sub>2</sub>O in patients sensitive

## Important information

to increased trans-pulmonary pressure may get one or more of the side effects listed below.

Clinical judgment should be used to select the right volume target for each patient based on age, gender and height. See Chart B at the end of this booklet.

Side effects may include:

- Increased work of breathing that may lead to breathing too slowly and high carbon dioxide levels
- Increased pressure in the brain
- Heart problems:
  - reduced blood flow to the heart (myocardial ischemia)
  - reduced blood flow back to the heart (decreased venous return)
- Air swallowing with increased likelihood of vomiting and 'secretions going down the wrong way' (aspiration)
- Fear of confined spaces (claustrophobia)
- Lung problems caused by pressure changes (pulmonary barotraumas)

# Using your iPEP in the hospital



### Getting ready

- 1** Look at the iPEP to make sure it is clean and does not contain anything that should not be in there. If there is something wrong with it, get it replaced.
- 2** Insert the OPEP module into the iPEP – put it into the OPEP position with the vents on top.
- 3** Put the iPEP mouthpiece tube into the tube port.

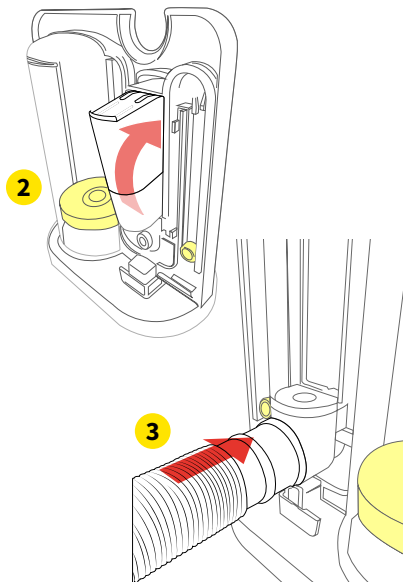

## Using your iPEP in the hospital

**4** To use the handle:

- Swing the handle down
- Push the handle up to gently lock into place.

**5** Fold the handle back into place when not being used.

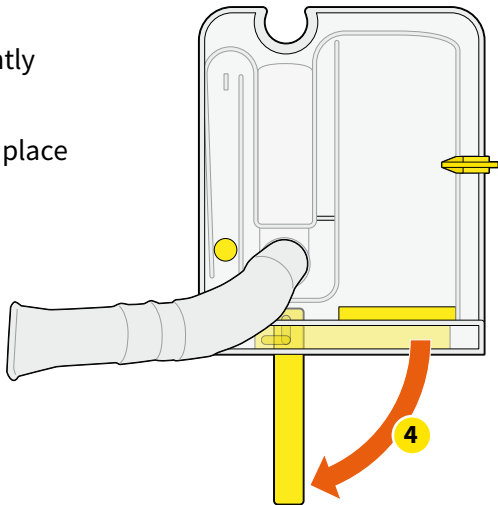

# How often to use the iPEP

Use the iPEP as often as your healthcare practitioner tells you to.

- After surgery, it may be too painful to take deep breaths. You may also feel too weak to take deep breaths. If you do not breathe deeply enough it can lead to lung illness.
- The goal is to keep your lungs clear and ventilation capacity up.
- If you are producing a lot of mucus your healthcare practitioner may tell you to use it more often.
- Keep using the iPEP even if you are bringing up just a little mucus.

## Starting to use the iPEP

- 1 Take the dust cap off the iPEP mouthpiece tube.
- 2 Sit up straight so that you are comfortable.
  - Your healthcare practitioner may tell you to use a nose clip – if needed.
- 3 Put the mouthpiece in your mouth.
  - Close your lips around it to make a good seal.

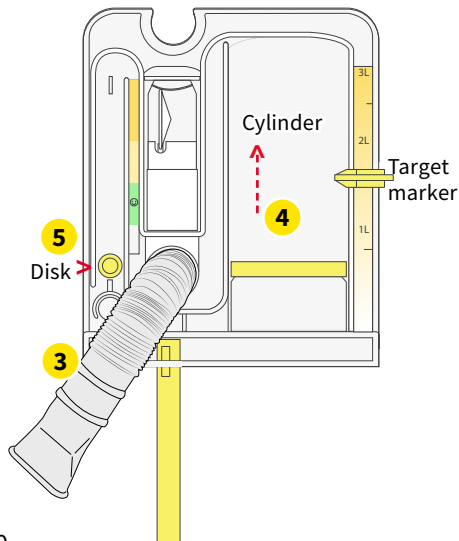

## Using your iPEP in the hospital

- 4 Take a slow breath in:
  - The cylinder will move up as you breathe in
  - Your healthcare practitioner may place the target marker to tell you how big of a breath you should take.
- 5 As you breathe in make sure that the disk stays in the middle of the green zone.
  - If you breathe in too quickly, the disk will shoot to the top
  - If you breathe in too slowly, the disk will stay at the bottom.

- 6 Hold your breath for 2 to 3 seconds.
- 7 Breathe out through the mouth-piece with more force than normal.

### Tip

Keep your cheeks flat and not puffed out – this will help you get the best from your treatment.

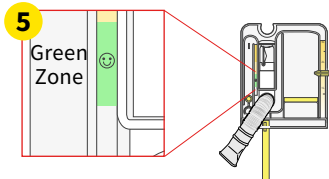

## Using your iPEP in the hospital

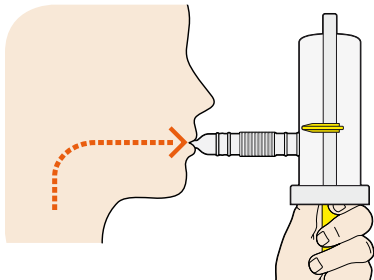
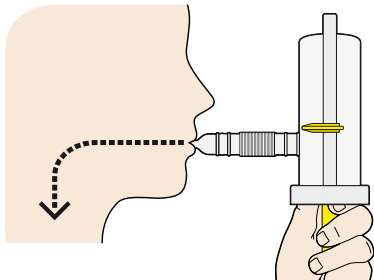

- 8** Keep taking deep breaths in – and forceful breaths out through your iPEP – 10 to 20 times
  - Your healthcare practitioner may tell you the number of breaths they want you to take.
- 9** After at least 10 breaths in and out, do 2 or 3 'huff coughs' to clear your lungs.
  - Your healthcare practitioner will teach you how to do a 'huff cough'.

## Using your iPEP in the hospital

- To get the best from your treatment, try to not cough until you have done 10 breaths in and out.

**10** Now repeat steps 4 to 9 four times, or as directed by your healthcare practitioner.

If you have any questions, contact your healthcare practitioner.

If you feel dizzy or light-headed while using the iPEP:

- Take the mouthpiece out of your mouth
- Take some normal breaths
- Then begin using it again

If you still feel dizzy or if you have any other problems while using the iPEP, stop treatment and talk to your healthcare practitioner.

# Using the spirometer in the hospital



## Getting ready

- 1 Take the OPEP module out by pushing down on the vents.

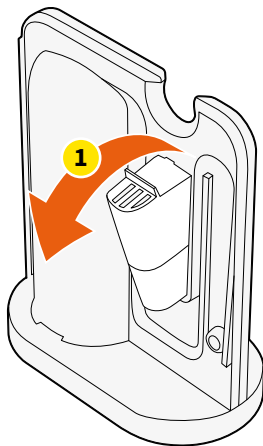

## Using the spirometer in the hospital

- 2 Then sit up straight and hold the handle.
- 3 Put the iPEP mouthpiece tube into the tube port.

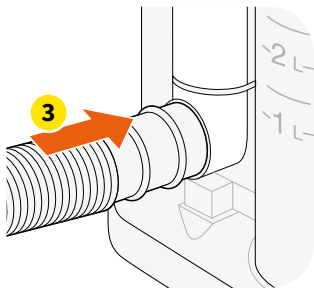

## How often to use the spirometer

Take 10 to 15 breaths when using the iPEP as a spirometer, or as directed by your healthcare practitioner.

## Using the spirometer

- 1 Take the dust cap off the iPEP mouthpiece tube.
- 2 Sit up straight so that you are comfortable.
  - Your healthcare practitioner may tell you to use a nose clip - if needed.
- 3 Put the mouthpiece in your mouth.
  - Close your lips around it to make a good seal.

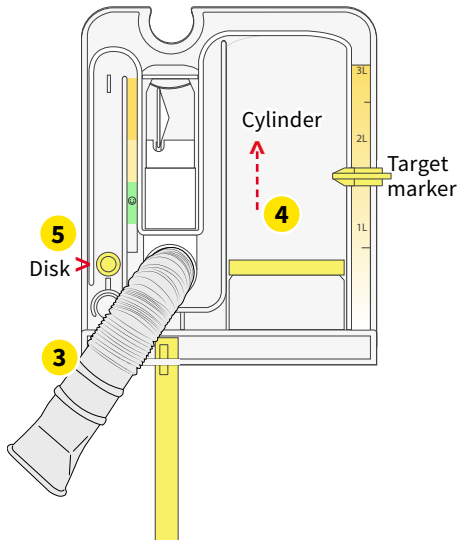

## Using the spirometer in the hospital

- Take a slow breath in:
  - The cylinder will move up as you breathe in.
  - Try to get the cylinder to move up as high as you can.
  - Your healthcare practitioner may place the target marker to tell you how big of a breath you should take.
- As you breathe in make sure that the disk stays in the middle of the green zone.
  - If you breathe in too quickly, the disk will shoot to the top.
  - If you breathe in too slowly, the disk will stay at the bottom.

- Breathe in as much as you can:
  - Hold your breath for 2 to 3 seconds.
- Breathe out.
  - Keep breathing in and out through the device.

If you feel dizzy or lightheaded while using the spirometer:

- Take the mouthpiece out of your mouth.
- Take some normal breaths.
- Then begin using it again.

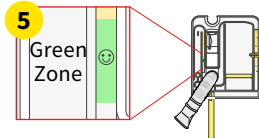

## Using the spirometer in the hospital

If you still feel dizzy or if you have any other problems while using the spirometer, stop treatment and talk to your healthcare practitioner.

### **Tip**

If you do not make the target marker level when you use the spirometer, do not worry. This will improve with practice and as your body heals.

# Using your PocketPEP at home

### Getting ready

Some of the iPEP parts can be used to make a smaller device called the PocketPEP. You can use this to continue your treatment at home.

- 1** Look at the iPEP to make sure it is clean and does not contain anything that should not be in there. If there is something wrong with it, get it replaced.
- 2** With the back of the iPEP facing you, take the OPEP module out.
- 3** Do this by pushing down on the vents and out towards you.

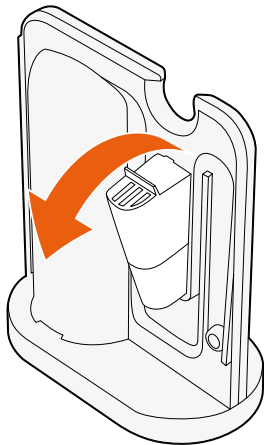



## Using your PocketPEP at home

- 4** Put the OPEP module in the PocketPEP case.
- 5** Push the OPEP mouth-piece firmly over the top of the module - push until it clicks on to the case.

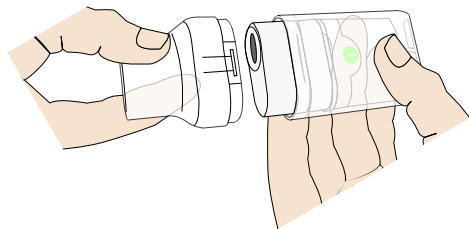
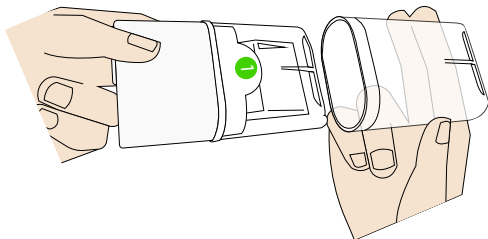

## How often to use the PocketPEP

Use the PocketPEP as often as your healthcare practitioner tells you to.

- This helps you to keep your lungs clear and able to breathe as well as possible.
- If you are producing a lot of mucus your healthcare practitioner may tell you to use it more often.
- Keep using it even if you are only bringing up a little mucus.

Keep the OPEP mouthpiece covered with the dust cap when you are not using it.

## Using the PocketPEP

- 1** Take the dust cap off the PocketPEP.
  - 2** Sit up straight so that you are comfortable.
  - 3** Your healthcare practitioner will direct which side should face up. Side 1 faces up for low resistance. Side 2 faces up for high resistance.
  - 4** Put the mouthpiece in your mouth:
- Close your lips around it to make a good seal
  - Make sure your hand does not cover the holes near the bottom
  - Your healthcare practitioner may tell you to use a nose clip – if needed.

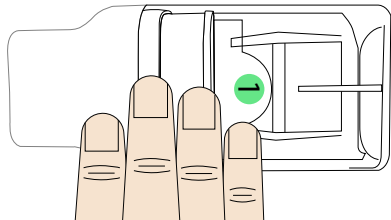

## Using your PocketPEP at home

**5** Take in a very slow deeper breath than normal:

- But do not fill your lungs all the way.
- Hold your breath for 2 to 3 seconds.

**6** Breathe out through the mouthpiece with more force than normal.

### Tip

Keep your cheeks flat and not puffed out – this will help you get the best from your treatment.

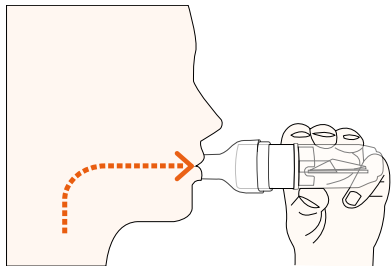
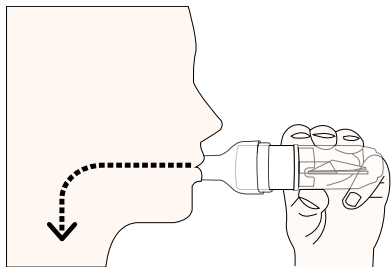

## Using your PocketPEP at home

- 7** Keep taking very slow deep breaths in - and long breaths out through the PocketPEP – 10 to 20 times.
  - Breathe out through the mouthpiece with more force than normal.
  - Your healthcare practitioner may tell you the number of breaths they want you to take.
- 8** After at least 10 breaths in and out, do 2 or 3 ‘huff coughs’ to clear your lungs.
  - Your healthcare practitioner will teach you how to do a ‘huff cough’.

- To get the best from your treatment, try not to cough until you have done 10 breaths in and out.

- 9** Now repeat steps 2 to 8 four times, or as directed by your healthcare practitioner.

If you feel dizzy or lightheaded while using the PocketPEP:

- Take the mouthpiece out of your mouth
- Take some normal breaths
- Then begin using it again

## Using your PocketPEP at home

If you still feel dizzy or if you have any other problems while using the PocketPEP, stop treatment and talk to your healthcare practitioner.

### Tip

If you have had an operation on your chest or belly, you may feel some discomfort when using the PocketPEP. If you hold a pillow tightly to your chest or belly while breathing, it may help.

# **Cleaning the PocketPEP at home**

## Taking the PocketPEP apart

- 1 Take off the dust cap and OPEP mouthpiece.
- 2 Take the OPEP module out of the PocketPEP case.

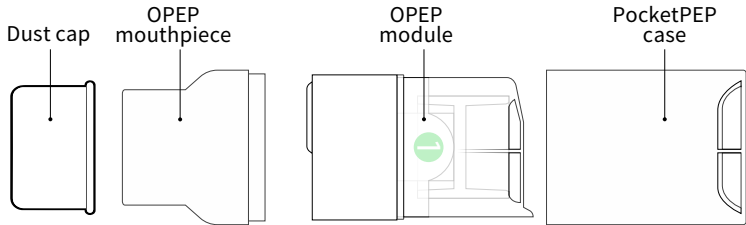



## Taking the OPEP module apart

The OPEP module is made of 3 pieces that can be taken apart.

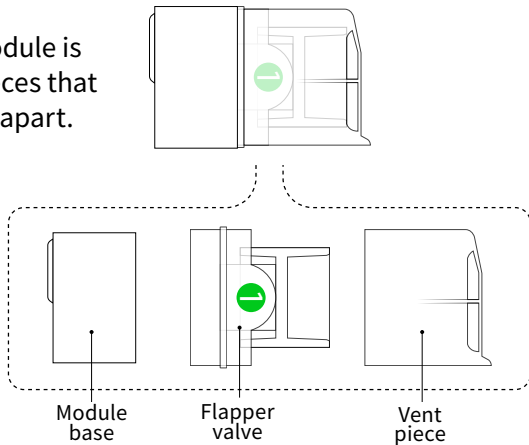

## Taking the OPEP module apart

- 1 Take the module base off the OPEP module.

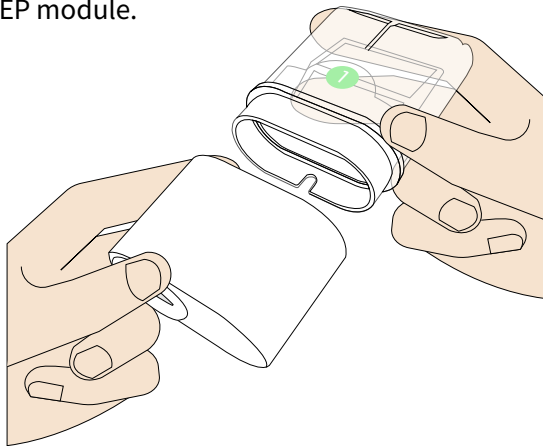

## Taking the OPEP module apart

- 2** Pull the flapper valve out of the vent piece.

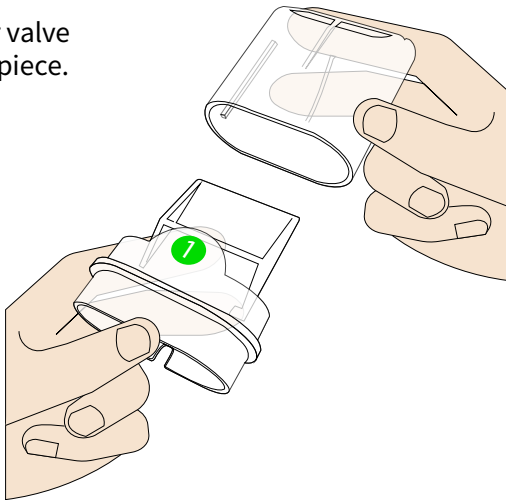

# Cleaning and Disinfecting the PocketPEP

*Healthcare practitioners should use clinical judgment to advise the appropriate cleaning and disinfecting based on the patient's condition.*

## A. Cleaning the PocketPEP in soap and water.

- Make sure that you have the 6 parts shown on page 35.
  - Wash the 6 parts in warm soapy water. You can use liquid detergent such as Dawn®.
  - Let the parts soak for 15 minutes, moving them around from time to time.
  - Then rinse in clean warm water.
  - Look at the parts. If they are still not clean wash them again.
- You can use a soft, lint-free cloth or soft bristle brush to help clean them.
- Check that the parts are not cracked, discolored or out of shape. If they are, stop using the PocketPEP and get it replaced.
  - Shake off any water from each part.
  - Leave the parts to dry. Make sure that there is no soap or water left in them before you put them back together.

## Cleaning and Disinfecting the PocketPEP

### B. Cleaning the PocketPEP in the dishwasher

- Put the 6 parts in a basket and place in the top rack of the dishwasher.
- Wash in a normal cycle with dishwasher detergent.
- Shake off any water from each part.
- Leave the parts to dry before you put them back together.

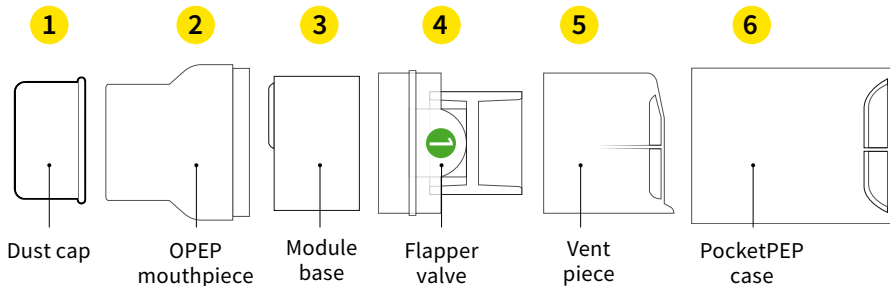

## Cleaning and Disinfecting the PocketPEP

**If clinically recommended, the PocketPEP can be cleaned after each use and disinfected once each treatment day according to option 1 or 2 below.**

### **1. Boiling**

- Take apart, wash and rinse the 6 parts as described on page 34 and 35. Do not reassemble.
- Boil water.
- Put the 6 disassembled parts in boiling water for 5 minutes. Place a cloth or heat resistant rack in the pot to keep the parts from resting directly on the hot bottom of the pot.

- Remove parts and allow to dry before you put them back together.

### **2. Microwave Steam Bag**

- The 6 disassembled parts may be disinfected in the microwave in a steam bag.
- Follow the steam bag instructions.
- Remove from bag and allow parts to cool and air dry before reassembly.

## Cleaning and Disinfecting the PocketPEP

**The PocketPEP can also be cold sterilized if desired according to option 3 or 4 below.**

### **3. Isopropyl Alcohol**

- Take apart, wash and rinse the 6 parts as described on page 34 and page 35. Do not reassemble.
- Fill a wash basin with enough 70% Isopropyl alcohol to submerge the 6 parts.
- After two minutes of soaking, put on plastic gloves and remove parts from the basin.
- Rinse the 6 parts well in sterile distilled water.
- Shake off any water from each part.

- Allow parts to dry before you put them back together.
- Empty and rinse the basin after cleaning.

### **4. Hydrogen Peroxide (3%)**

- The 6 parts may be soaked in (3%) Hydrogen Peroxide for 30 minutes.
- Rinse well in sterile distilled water.

Patient Name .....

Room Number/File Number .....

Authorized Signature .....

Notes .....

.....

.....

.....

.....

.....

.....



## Chart A: Patient Progress Chart for Incentive Spirometer-Only Use

	3000ml							
	2750ml							
	2500ml							
	2250ml							
	2000ml							
	1750ml							
	1500ml							
	1250ml							
	1000ml							
	750ml							
	500ml							
	250ml							
	Day	1	2	3	4	5	6	7
	Goal							

## Chart B: Predictive Nomogram – Inspiratory Capacity\* (mL)\*\* Female

Age in Years	Height in Inches								
	58	60	62	64	66	68	70	72	74
20	1900	2100	2300	2500	2700	2900	3100	3300	3500
25	1850	2050	2250	2450	2650	2850	3050	3250	3450
30	1800	2000	2200	2400	2600	2800	3000	3200	3400
35	1750	1950	2150	2350	2550	2750	2950	3150	3350
40	1700	1900	2100	2300	2500	2700	2900	3100	3300
45	1650	1850	2050	2250	2450	2650	2850	3050	3250
50	1600	1800	2000	2200	2400	2600	2800	3000	3200
55	1550	1750	1950	2150	2350	2550	2750	2950	3150
60	1500	1700	1900	2100	2300	2500	2700	2900	3100
65	1450	1650	1850	2050	2250	2450	2650	2850	3050
70	1400	1600	1800	2000	2200	2400	2600	2800	3000
75	1350	1550	1750	1950	2150	2350	2550	2750	2950
80	1300	1500	1700	1900	2100	2300	2500	2700	2900

\*D R Burton Healthcare recommends setting the Target Marker at 60% of the Inspiratory Capacity for patients based on this chart for use in OPEP therapy.

\*Formula used in the above Nomogram was published in The American Review of Respiratory Diseases official journal of American Thoracic Society September 1979 Vol 120, Number 3, By G Polgar and V. Promadhat

\*\*Milliliters-Inspiratory Capacity measured in milliliters rounded off to the nearest 50ml.

## Chart B: Predictive Nomogram – Inspiratory Capacity\* (mL)\*\* Male

Age in Years	Height in Inches										
	58	60	62	64	66	68	70	72	74	76	78
20	2000	2200	2400	2600	2800	3000	3200	3400	3600	3800	4000
25	1950	2150	2350	2550	2750	2950	3150	3350	3550	3750	3950
30	1900	2100	2300	2500	2700	2900	3100	3300	3500	3700	3900
35	1800	2000	2200	2400	2600	2800	3000	3200	3400	3600	3800
40	1750	1950	2150	2350	2550	2750	2950	3150	3350	3550	3750
45	1700	1900	2100	2300	2500	2700	2900	3100	3300	3500	3700
50	1650	1850	2050	2250	2450	2650	2850	3050	3250	3450	3650
55	1550	1750	1950	2150	2350	2550	2750	2950	3150	3350	3550
60	1500	1700	1900	2100	2300	2500	2700	2900	3100	3300	3500
65	1400	1600	1800	2000	2200	2400	2600	2800	3000	3200	3400
70	1350	1550	1750	1950	2150	2350	2550	2750	2950	3150	3350
75	1300	1500	1700	1900	2100	2300	2500	2700	2900	3100	3300
80	1250	1450	1650	1850	2050	2250	2450	2650	2850	3050	3250

\*D R Burton Healthcare recommends setting the Target Marker at 60% of the Inspiratory Capacity for patients based on this chart for use in OPEP therapy.

\*Formula used in the above Nomogram was published in The American Review of Respiratory Diseases official journal of American Thoracic Society September 1979 Vol 120, Number 3, By G Polgar and V. Promadhat

\*\*Milliliters-Inspiratory Capacity measured in milliliters rounded off to the nearest 50ml.

Single patient use only.  
Do not share or use on  
multiple patients.

Not manufactured from  
latex natural rubber.

**D R Burton Healthcare LLC**

3936 South Fields Street  
Farmville, NC 27828

Telephone: 252-228-7038

Website: [www.drburtonhpi.com](http://www.drburtonhpi.com)

Reorder number 522

Made in the USA

U.S. Patent 9,233,274 B2 and other patents  
pending.

iPEP, PocketPEP and D R Burton Healthcare  
are registered trademarks  
of D R Burton Healthcare LLC.

© 2018, D R Burton Healthcare LLC.  
All rights reserved.

IFU Part number 362rev02